

**vtech**<sup>®</sup>

User's Manual

**Go!Go!  
Smart Wheels**<sup>®</sup>  
*Playtime with miles of learning!*

**Park & Learn Deluxe Garage**<sup>™</sup>

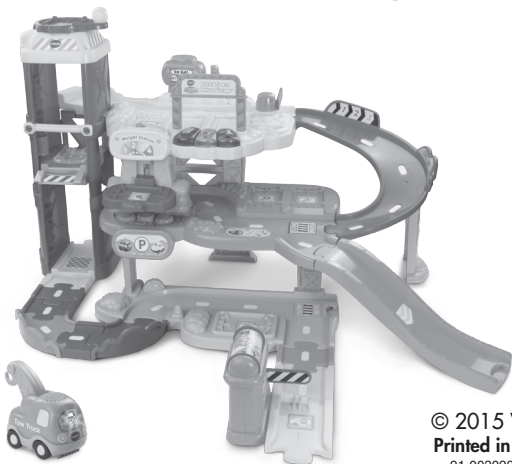

© 2015 VTech  
Printed in China  
91-003022-004 US

Dear Parent,

Welcome to the world of **Go! Go! Smart Wheels**®! We're excited you've decided to ride along with us and explore all that **Go! Go! Smart Wheels**® has to offer. These toys have been designed to give your child a thrilling learning experience with hours and hours of fun as well.

**Go! Go! Smart Wheels**® features vehicles that interact with your child by lighting up, singing and talking, while teaching your child letters and vehicle names (each sold separately). There are other surprises in store, too! With our innovative **SmartPoint**® technology, available on **Go! Go! Smart Wheels**® playsets (each sold separately), your child will smile as they hear **SmartPoint**® vehicles respond to each unique **SmartPoint**® location with singing, sound effects and fun phrases.

Our **Go! Go! Smart Wheels**® playsets also feature buttons, gears and other mechanical features to encourage the development of your child's fine motor skills. Many of the playsets also have tracks that can be arranged in endless ways, stimulating your child's creativity. In addition, all the **Go! Go! Smart Wheels**® playsets connect to other playsets in the collection, so there's no end to what your child can do!

With **Go! Go! Smart Wheels**®, it's playtime with miles of learning!

Sincerely,  
Your friends at **VTech**®

To learn more about **VTech**® toys, visit [vtechkids.com](http://vtechkids.com)

# INTRODUCTION

Thank you for purchasing the **VTech® Go! Go! Smart Wheels® Park & Learn Deluxe Garage™!**

Park, play and learn with the **Go! Go! Smart Wheels® Park & Learn Deluxe Garage™.** This interactive garage features three floors of pretend play and learning fun.

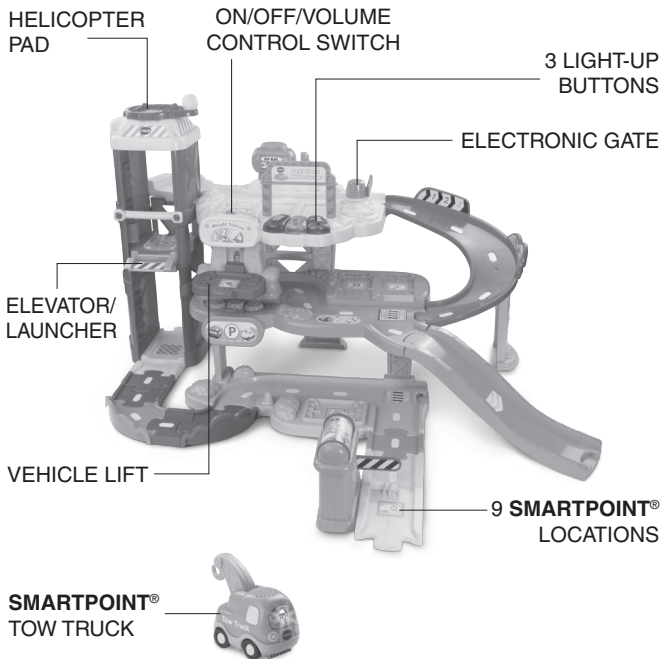

## INCLUDED IN THIS PACKAGE



One **SmartPoint**<sup>®</sup>  
tow truck



One elevator tower



One vehicle lift



One fuel accessory



One welcome gate



One **SmartPoint**<sup>®</sup>  
toll booth



One curved ramp track



One straight ramp track



One first floor  
**SmartPoint**<sup>®</sup> platform

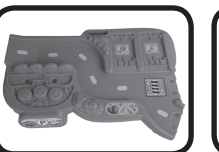

One second floor  
**SmartPoint**<sup>®</sup> platform



One third floor  
**SmartPoint**<sup>®</sup> platform

INCLUDED IN THIS PACKAGE



- One snap-in large support
- One medium support
- One snap-in small support
- One mini support
- Two snap-in mini supports

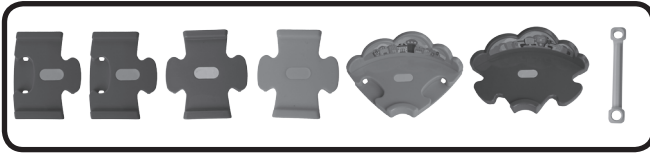

- Two male/female connector tracks
- Two male connector tracks
- One 90-degree female track
- One 90-degree male track
- One elevator support piece

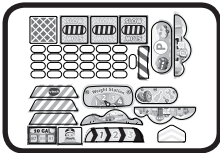

- One label sheet
- One user's manual

INCLUDED IN THIS PACKAGE

### WARNING:

All packing materials, such as tape, plastic sheets, packaging locks and tags are not part of this toy, and should be discarded for your child's safety.

### ATTENTION:

Pour la sécurité de votre enfant, débarrassez-vous de tous les produits d'emballage tels que rubans adhésifs, feuilles de plastique, attaches et étiquettes. Ils ne font pas partie du jouet.

### NOTE:

Please keep this user's manual as it contains important information.



## CAUTION:

Adult assembly required. For your child's safety, do not let your child play with the toy until it is fully assembled.

Unlock the packaging locks:

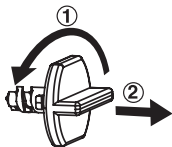

- ① Turn the packaging lock counter-clockwise several times.
- ② Pull out and discard the packaging lock.

## GETTING STARTED

### BATTERY INSTALLATION – TOW TRUCK

1. Make sure the unit is turned **OFF**.
2. Locate the battery cover on the bottom of the tow truck. Use a coin or a screwdriver to loosen the screw.

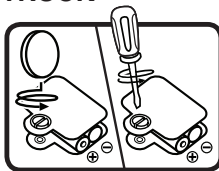

3. Install 2 new “AAA” (AM-4/LR03) batteries following the diagram inside the battery box. (The use of new alkaline batteries is recommended for maximum performance.)
4. Replace the battery cover and tighten the screw to secure the battery cover.

## BATTERY INSTALLATION - GARAGE

1. Make sure the unit is turned **OFF**.
2. Locate the battery cover on the top platform of the **Park & Learn Deluxe Garage™**. Use a screwdriver to loosen the screw.
3. Install 2 new ‘AA’ (AM-3/LR6) batteries following the diagram inside the battery box. (The use of new alkaline batteries is recommended for maximum performance.)
4. Replace the battery cover and tighten the screw to secure the battery cover.

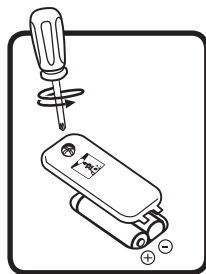

## BATTERY NOTICE

- Use new alkaline batteries for maximum performance.
- Use only batteries of the same or equivalent type as recommended.
- Do not mix different types of batteries: alkaline, standard (carbon-zinc) or rechargeable (Ni-Cd, Ni-MH), or new and used batteries.
- Do not use damaged batteries.
- Insert batteries with the correct polarity.
- Do not short-circuit the battery terminals.
- Remove exhausted batteries from the toy.
- Remove batteries during long periods of non-use.
- Do not dispose of batteries in fire.
- Do not charge non-rechargeable batteries.

- Remove rechargeable batteries from the toy before charging (if removable).
- Rechargeable batteries are only to be charged under adult supervision.

**Please adhere the labels to the playset securely as indicated on the following page:**

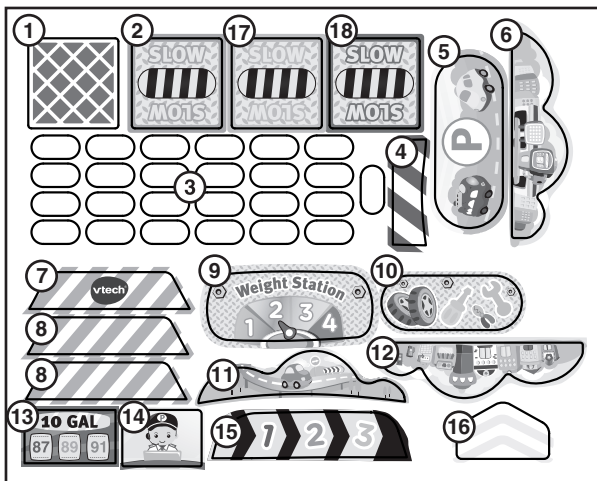



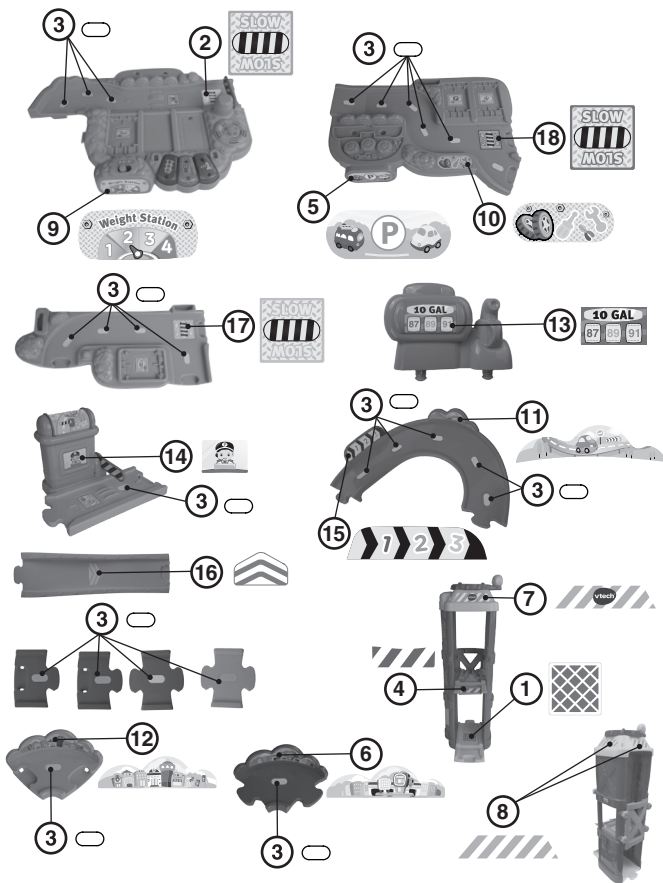

# LABEL INSTRUCTIONS

# ASSEMBLY INSTRUCTIONS

With the VTech® Go! Go! Smart Wheels® Park & Learn Deluxe Garage™ safety comes first. To ensure your child's safety, adult assembly is required.

1. With the first floor platform right-side up, insert the two snap-in mini supports into the slots on the first floor platform as shown. The snap-in mini supports will fit in the slots snugly. The teeth on the snap-in mini supports will grip to the first floor platform.

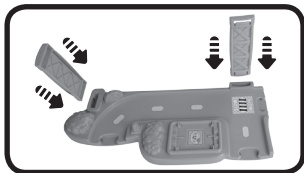

2. With the second floor platform upside-down, insert the snap-in small support into the slot on the second floor platform as shown. The snap-in small support will fit in the slot snugly. The tooth on the small support will grip to the second floor platform.

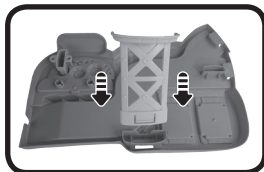

3. Flip the second floor platform right-side up. Next, connect the open second floor platform support slots to the snap-in mini supports attached to the first floor platform as shown. Press down to make sure the pieces are securely connected.

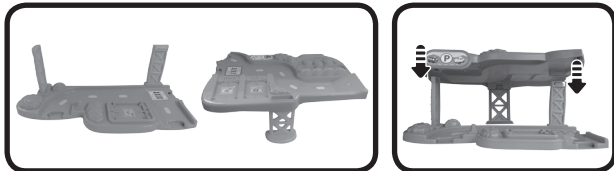

4. Insert the bottom of the vehicle lift into the second floor platform as shown. You will hear a “click” sound to indicate the vehicle lift is secure. Once the vehicle lift is connected to the second floor platform, it cannot be detached.

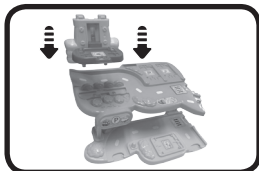

5. Insert either side of the mini support into the slot on the second floor platform as shown.

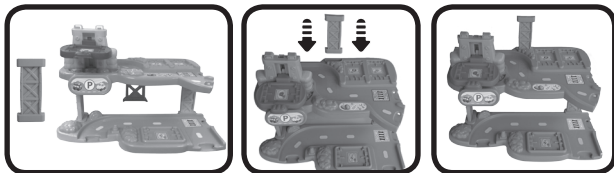

6. With the third floor platform upside-down, insert the snap-in large support into the largest slot on the third floor platform as shown. The snap-in large support will fit in the slot snugly. The tooth on the snap-in large support will grip to the third floor platform.

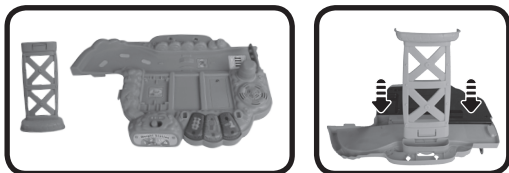

7. Flip the third floor platform right-side up. Next, line-up the vehicle lift and mini support with the third floor platform slot openings as shown. Then, press down on the third floor platform to secure it to the vehicle lift and mini support.



8. Attach the curved ramp track to the second floor platform and third floor platform as shown.

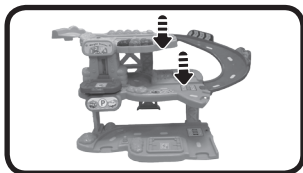

9. Insert the medium support into the slot on the bottom of the curved ramp track as shown.

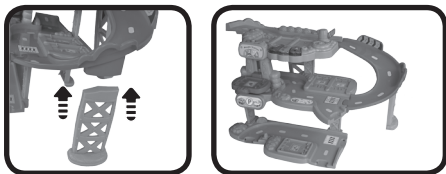

10. Attach the straight ramp track into the second floor platform as shown.

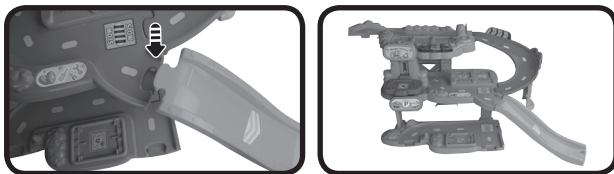

11. Attach the elevator tower to the third floor platform. First, connect the track portion of the third floor platform to the back of the elevator tower as shown. Next, connect the open slot on the elevator tower to the connector piece on the third floor platform as shown. You will hear a “click” sound to indicate the elevator tower is secured to the third floor platform. Once the elevator tower is connected to the third floor platform, it cannot be detached.

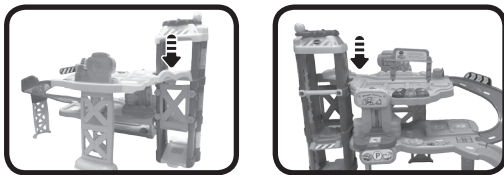

12. Attach the fuel accessory to the third floor platform as shown. You will hear a “click” sound to indicate the fuel accessory is secured to the third floor platform. Once the fuel accessory is connected to the third floor platform, it cannot be detached.



13. Attach the welcome gate to the third floor platform as shown.

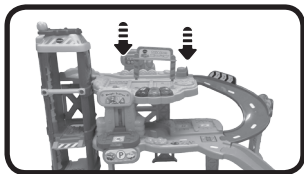

14. With the elevator/launcher at the base of the elevator tower, attach the elevator support piece to the elevator tower as shown. You will hear a “click” sound to indicate the elevator support piece is secured to the elevator tower. Once the elevator support piece is connected to the elevator tower, it cannot be detached.



Once you've completed the above steps, you are ready to play! You can connect these pieces to the other included track pieces or you can connect this playset to other **Go! Go! Smart Wheels®** and **Go! Go! Smart Animals™** playsets (each sold separately).

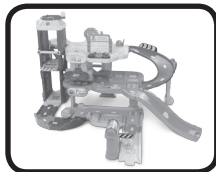
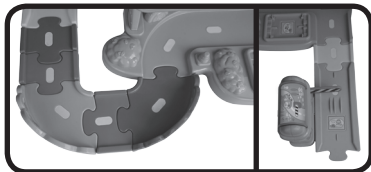

## EXPAND & EXPLORE

Connect to the **Go! Go! Smart Wheels® Deluxe Track Set** (as shown below) or other **Go! Go! Smart Wheels®** and **Go! Go! Smart Animals™** playsets (each sold separately) to expand the **Park & Play Deluxe Garage** and inspire creativity.

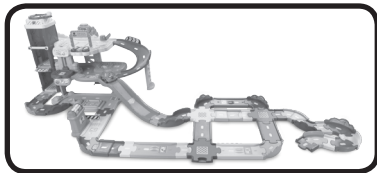

## PRODUCT FEATURES – TOW TRUCK

### 1. ON/OFF SWITCH

To turn the tow truck **ON**, slide the **ON/OFF SWITCH** on the tow truck to the **ON** (☺) position. To turn the tow truck **OFF**, slide the **ON/OFF SWITCH** to the **OFF** (●) position.

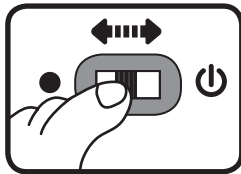

## 2. AUTOMATIC SHUT-OFF

To preserve battery life, the tow truck included with the **VTech® Go! Go! Smart Wheels® Park & Learn Deluxe Garage™** will automatically power-down after approximately 65 seconds without input. The unit can be turned on again by pressing the light-up driver button or pushing the tow truck quickly.

**Note:** This product is in try-me mode in the packaging. After opening the package, turn the vehicle off and on again to proceed with normal play.

## ACTIVITIES – TOW TRUCK

1. Slide the **ON/OFF SWITCH** to the **ON** position to turn the unit **ON**. You will hear a song, a phrase and sounds. The light will flash with the sounds.

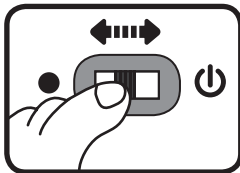

2. Press the light-up driver button to hear tow truck sounds, songs and phrases. The light will flash with the sounds.



3. Push the tow truck to hear fun sounds, and melodies. While the melody is playing, push the vehicle again to add in fun sounds on top of the melody. The light will flash with the sounds.

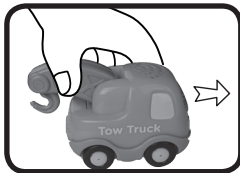





4. For added fun, the tow truck interacts with the **Go! Go! Smart Wheels® Park & Learn Deluxe Garage™**. Simply roll or place the tow truck on one of the playset's **SmartPoint®** locations to hear the tow truck play sounds, short tunes and sing-along songs. The tow truck even interacts with other **Go! Go! Smart Wheels®** and **Go! Go! Smart Animals™** playsets (each sold separately).

## PRODUCT FEATURES - GARAGE

### 1. ON/OFF/VOLUME CONTROL SWITCH

To turn the unit **ON**, slide the **ON/OFF/VOLUME CONTROL SWITCH** to the low volume (  ) or high volume (  ) position. To turn the unit **OFF**, slide the **ON/OFF/VOLUME CONTROL SWITCH** to the **OFF** (  ) position.

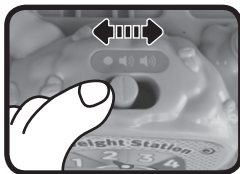

### 2. SMARTPOINT® LOCATIONS

The **Park & Learn Deluxe Garage™** includes 9 **SmartPoint®** locations that interact with the included tow truck or any other **Go! Go! Smart Wheels® SmartPoint®** vehicle (each sold separately). Simply roll or place the vehicle over a **SmartPoint®** location to hear fun sounds, phrases and music.



### 3. AUTOMATIC SHUT-OFF

To preserve battery life, the **VTech® Go! Go! Smart Wheels® Park & Learn Deluxe Garage™** will automatically power-down after approximately 55 seconds without input. To wake up the unit, activate any of the electronic features on the playset.

## ACTIVITIES - GARAGE

1. Slide the **ON/OFF/VOLUME CONTROL SWITCH** to either volume setting to turn the unit on. You will hear a song, phrase and fun sounds. The lights will flash with the sounds.

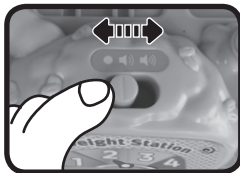

2. Press the **LIGHT-UP BUTTONS** to hear fun phrases, sounds, songs and melodies. While a melody is playing, press any of the 3 **LIGHT-UP BUTTONS** to add in fun sounds on top of the melody. The lights will flash with the sounds.



3. Place a vehicle on the **ELEVATOR/LAUNCHER**, and rotate the **HELICOPTER PAD** clockwise or counter-clockwise. Based on the way the **HELICOPTER PAD** is rotated, the **ELEVATOR/LAUNCHER** will go up or down the **ELEVATOR TOWER**. As the **ELEVATOR/LAUNCHER** reaches each floor you will hear fun sounds and phrases. When the **ELEVATOR/LAUNCHER** reaches the third floor, it will trigger the launcher button.

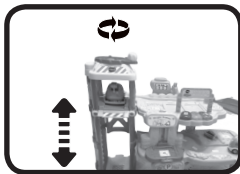

4. Raise the **VEHICLE LIFT** up to hear fun sounds. The lights will flash with the sounds.



5. Raise the **ELECTRONIC GATE** up or down to hear fun sounds and a phrase. The lights will flash with the sounds.



## SONG LYRICS

### Park & Learn Deluxe Garage™

#### SONG 1

Here's your parking ticket,  
Drive on through.  
Enjoy your stay.  
There is so much to do!

#### SONG 2

Ride the elevator floor to floor.  
There are so many fun things to explore.

#### SONG 3

Fill up here,  
Parking there,  
Thanks for visiting and please take care!

## MELODY LIST

### Park & Learn Deluxe Garage™

1. Alexander's Ragtime Band
2. Green Grass Grew All Around
3. Bicycle Built for Two
4. Chicken Reel
5. Farmer in the Dell
6. It's Raining, It's Pouring
7. Muffin Man
8. Where Has My Little Dog Gone
9. One, Two, Buckle My Shoe
10. Polly Wolly Doodle
11. Shoo Fly
12. Ten Little Indians

## CARE & MAINTENANCE

1. Keep the unit clean by wiping it with a slightly damp cloth.
2. Keep the unit out of direct sunlight and away from any direct heat source.
3. Remove the batteries when the unit will not be in use for an extended period of time.
4. Do not drop the unit on hard surfaces and do not expose the unit to moisture or water.

# TROUBLESHOOTING

If for some reason the program/activity stops working or malfunctions, please follow these steps:

1. Please turn the unit **OFF**.
2. Interrupt the power supply by removing the batteries.
3. Let the unit sit for a few minutes, then replace the batteries.
4. Turn the unit **ON**. The unit should now be ready to play again.
5. If the product still does not work, replace with an entire set of new batteries.

If the problem persists, please call our Consumer Services Department at 1-800-521-2010 in the U.S. or 1-877-352-8697 in Canada, and a service representative will be happy to help you.

For information on this product's warranty, please call VTech® at 1-800-521-2010 in the U.S. or 1-877-352-8697 in Canada.

## IMPORTANT NOTE:

Creating and developing **Infant Learning** products is accompanied by a responsibility that we at **VTech®** take very seriously. We make every effort to ensure the accuracy of the information, which forms the value of our products. However, errors sometimes can occur. It is important for you to know that we stand behind our products and encourage you to call our Consumer Services Department at 1-800-521-2010 in the U.S. or 1-877-352-8697 in Canada, with any problems and/or suggestions that you might have. A service representative will be happy to help you.

## Note:

This equipment has been tested and found to comply with the limits for a Class B digital device, pursuant to Part 15 of the FCC Rules. These limits are designed to provide reasonable protection against harmful interference in a residential installation. This equipment generates, uses and can radiate radio frequency energy and, if not installed and used in accordance with the instructions, may cause harmful interference to radio communications. However, there is no guarantee that interference will not occur in a particular installation. If this equipment does cause harmful interference to radio or television reception, which can be determined by turning the equipment off and on, the user is encouraged to try to correct the interference by one or more of the following measures:

- Reorient or relocate the receiving antenna.
- Increase the separation between the equipment and receiver.
- Connect the equipment into an outlet on a circuit different from that to which the receiver is connected.
- Consult the dealer or an experienced radio/TV technician for help.

**Caution:** Changes or modifications not expressly approved by the party responsible for compliance could void the user's authority to operate the equipment.

THIS DEVICE COMPLIES WITH PART 15 OF THE FCC RULES. OPERATION IS SUBJECT TO THE FOLLOWING TWO CONDITIONS:  
(1) THIS DEVICE MAY NOT CAUSE HARMFUL INTERFERENCE, AND  
(2) THIS DEVICE MUST ACCEPT ANY INTERFERENCE RECEIVED, INCLUDING INTERFERENCE THAT MAY CAUSE UNDESIRE  
D OPERATION.

*CAN ICES-3 (B)/NMB-3(B)*



## PRODUCT WARRANTY

This Warranty is applicable only to the original purchaser, is non-transferable and applies only to "VTech" products or parts. This product is covered by a 3-month Warranty from the original purchase date, under normal use and service, against defective workmanship and materials. This Warranty does not apply to (a) consumable parts, such as batteries; (b) cosmetic damage, including but not limited to scratches and dents; (c) damage caused by use with non-VTech products; (d) damage caused by accident, misuse, unreasonable use, immersion in water, neglect, abuse, battery leakage, or improper installation, improper service, or other external causes; (e) damage caused by operating the product outside the permitted or intended uses described by VTech in the owner's manual; (f) a product or part that has been modified (g) defects caused by normal wear and tear or otherwise due to the normal aging of the product; or (h) if any VTech serial number has been removed or defaced.

Prior to returning a product for any reason, please notify the VTech Consumer Services Department, by sending an email to [vtechkids@vtechkids.com](mailto:vtechkids@vtechkids.com) or calling 1-800-521-2010. If the service representative is unable to resolve the issue, you will be provided instructions on how to return the product and have it replaced under Warranty. Return of the product under Warranty must adhere to the following rules:

If VTech believes that there may be a defect in the materials or workmanship of the product and can confirm the purchase data and location of the product, we will at our discretion replace the product with a new unit or product of comparable value. A replacement product or parts assumes the remaining Warranty of the original product or 30 days from the date of replacement, whichever provides longer coverage.

**THIS WARRANTY AND THE REMEDIES SET FORTH ABOVE ARE EXCLUSIVE AND IN LIEU OF ALL OTHER WARRANTIES, REMEDIES AND CONDITIONS, WHETHER ORAL, WRITTEN, STATUTORY, EXPRESS OR IMPLIED. IF VTECH CANNOT LAWFULLY DISCLAIM STATUTORY OR IMPLIED WARRANTIES THEN TO THE EXTENT PERMITTED BY LAW, ALL SUCH WARRANTIES SHALL BE LIMITED TO THE DURATION OF THE EXPRESS WARRANTY AND TO THE REPLACEMENT SERVICE AS DETERMINED BY VTECH IN ITS SOLE DISCRETION.**

To the extent permitted by law, VTech will not be responsible for direct, special, incidental or consequential damages resulting from any breach of Warranty.

This Warranty is not intended to persons or entities outside the United States of America. Any disputes resulting from this Warranty shall be subject to the final and conclusive determination of VTech.